

SINGLE HANDLE WALL MOUNT LAVATORY ROUGH-IN VALVE

Description

- Single handle rough-in valve
- Combination 1/2" copper sweat/IPS connection
- Mounting plate included

Flow & Valving

- See Chart

Standards

- ASME A112.18.1
- CSA B125
- NSF 61-9
- Listed IAPMO/UPC

Warranty

Danze products are covered by a manufacturer's limited "lifetime" warranty for manufacturing defects.



D106200BT

Special Packaging

- Trim kits for this valve are packaged separately

Available Models

- Fits Danze Single handle wall mount faucet trims
- Model numbers for trim kit items include the suffix "T"

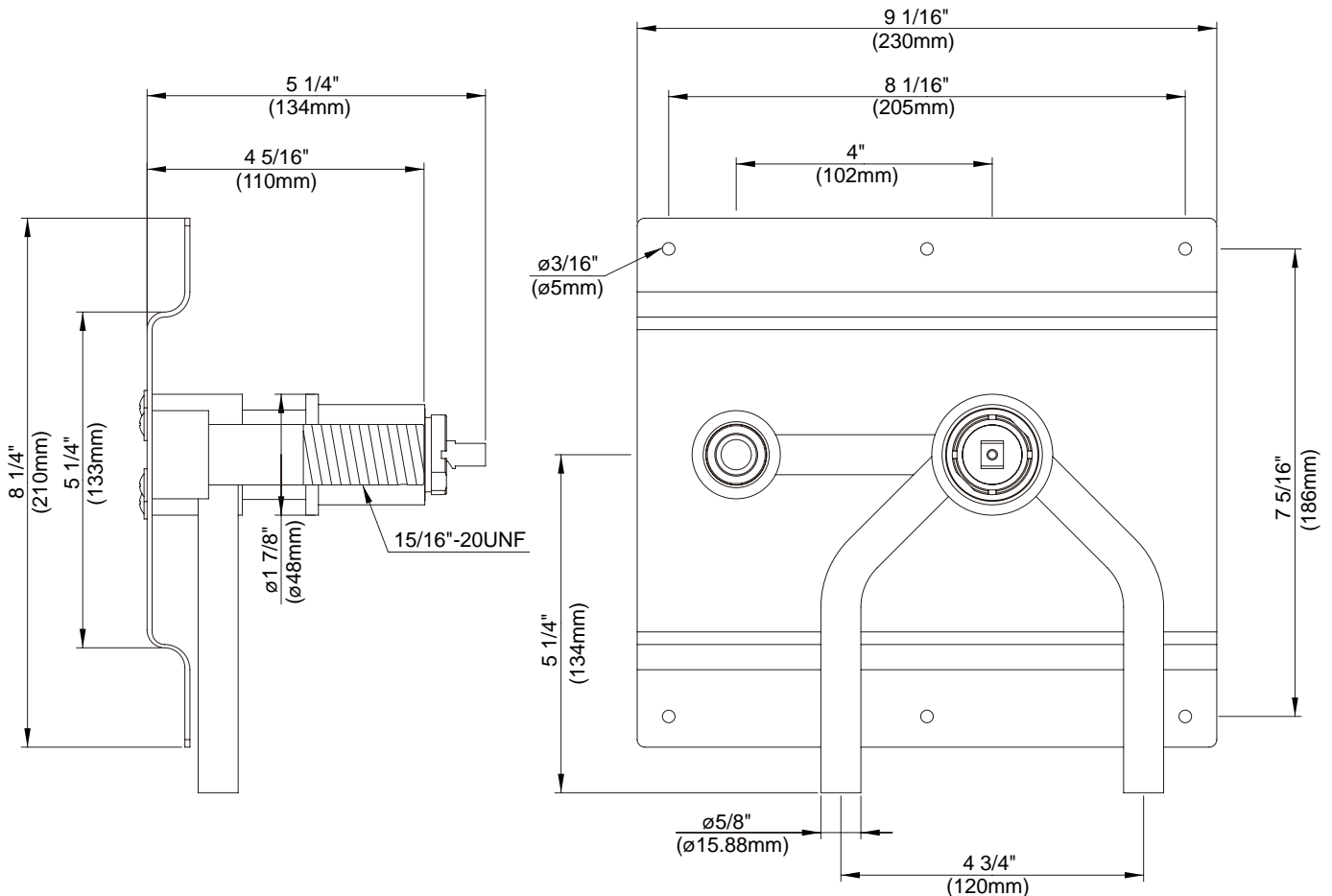
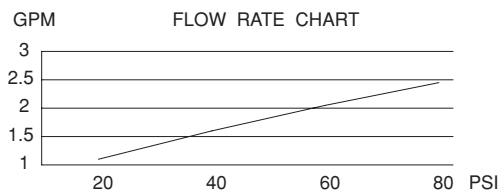

Specific Features: _____ Submitted Model No.: _____

SD106200BT/01-07.01