

SINGLE CONTROL PRESSURE BALANCE MIXING VALVE WITH SCREWDRIVER STOPS

Description

- Temperature limit adjustment
- Back to back installation feature
- Mounting bracket & plaster guard included

Flow & Valving

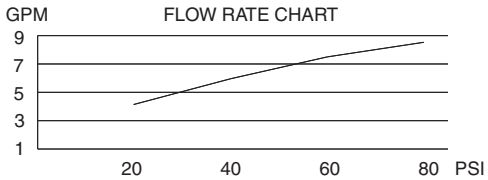

Standards

- ASME A112.18.1
- CSA B125
- ASSE 1016
- Listed IAPMO/UPC

Warranty

Danze products are covered by a manufacturer's limited "lifetime" warranty for manufacturing defects.

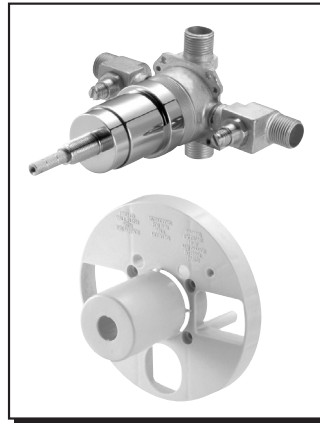

D112000BT

Available Colors & Finish

- Rough Brass

Special Packaging

- Trim kits for this valve are packaged separately. Fits all Danze single handle tub/shower & shower only trims
- Model numbers for trim kit items include the suffix "T"

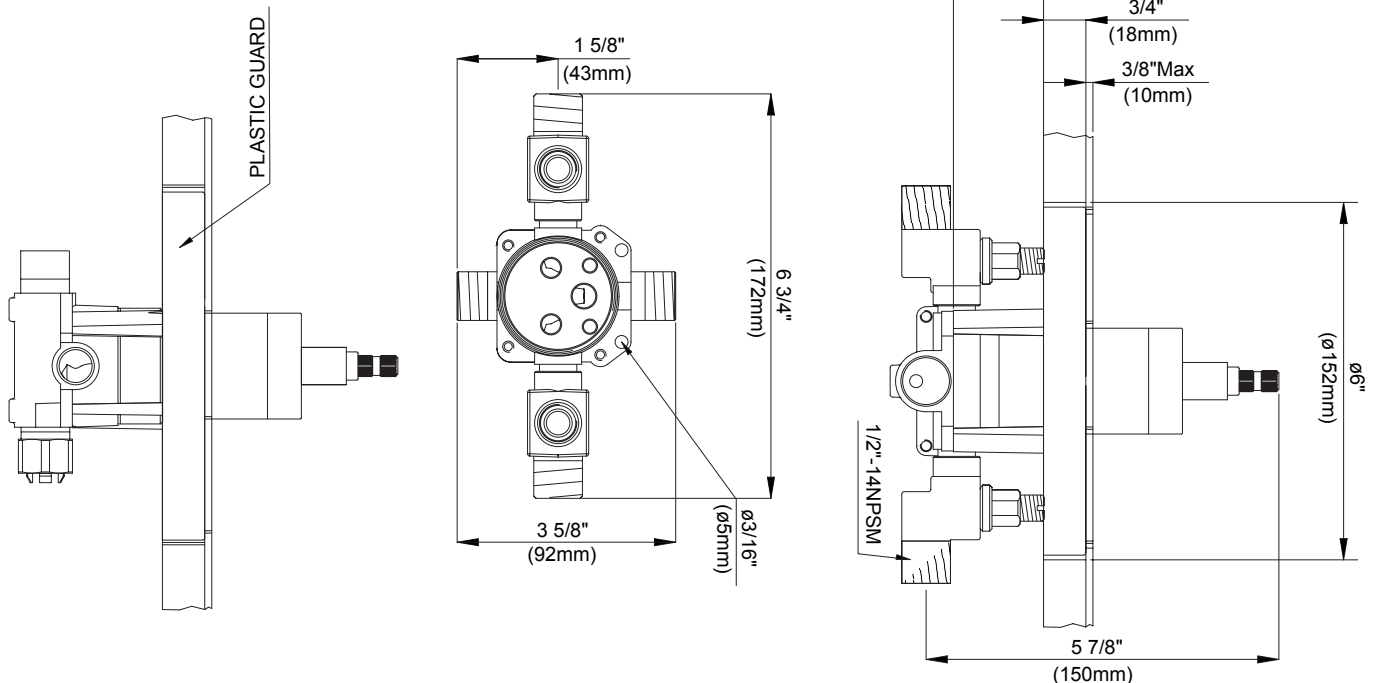

Specific Features: _____ Submitted Model No.: _____

SD112000BT/07-05.01